

TAKEX OUTDOOR PASSIVE SENSOR

MS-100E

Instruction Manual

Thank you for purchasing a TAKEX product.

This switch will provide long and dependable service when properly installed.

Please read this Instruction Manual carefully for correct and effective use.

Please Note : This switch is designed to detect passing objects and to initiate a signal ; it is not a burglary-preventing device. TAKEX is not responsible for damage or losses caused by accident, theft, Acts of God (including lightning), abuse, misuse, abnormal usage, faulty installation or improper maintenance.

1 PRODUCT DESCRIPTION

This sensor unit uses a passive infrared sensors to detect infrared (\cong body temperature) emitted from a human body, which can be used as an automatic switch.

This unit is designed for wide applications such as a switch to control illumination or home automation apparatus.

2 PARTS DESCRIPTION

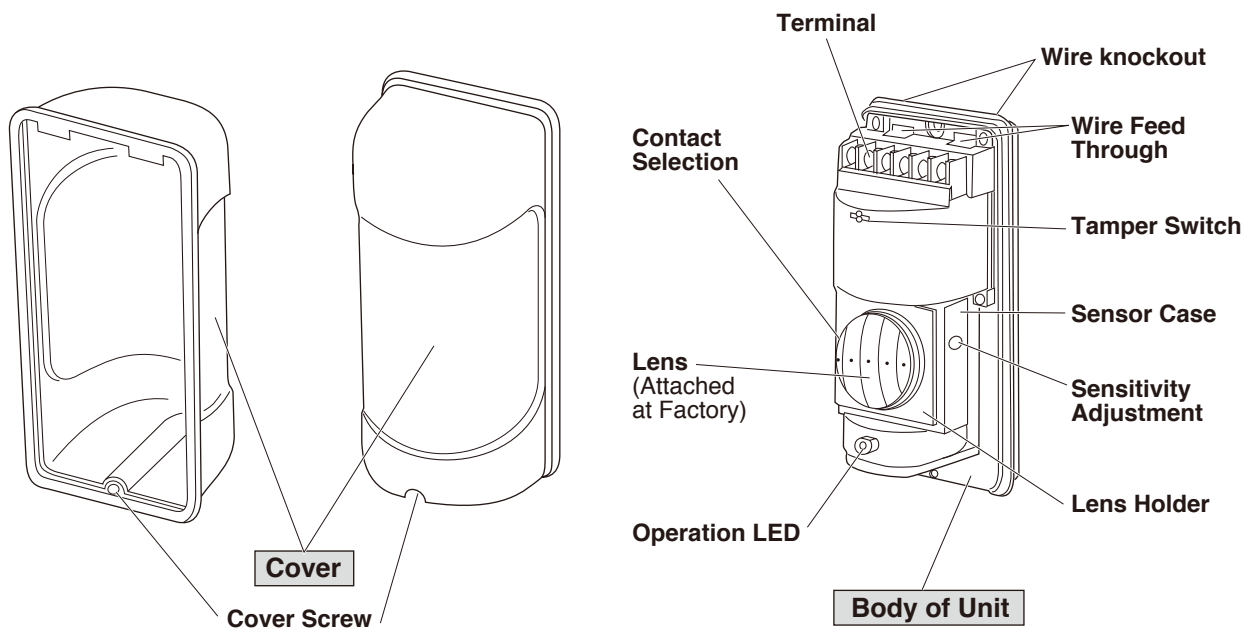

Filter

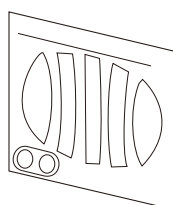

Masking Seal

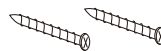

Screws : 2



Lens For Long Range

3 PRECAUTIONS

1. Precautions on Installation

- Install the unit in such a direction that people are more likely to cross the detection zones.

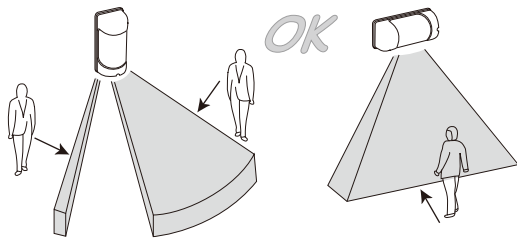

- For horizontal installation, do not install in a site which is subject to rainfall.

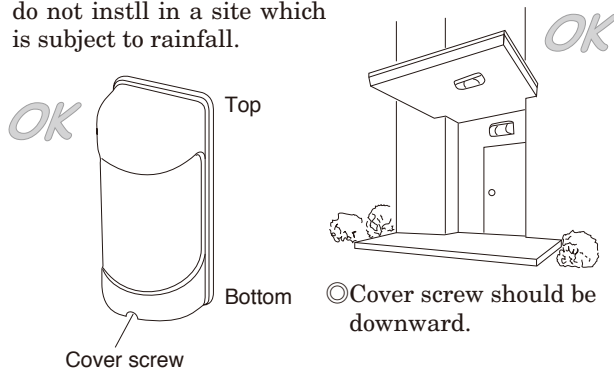

- The unit should be installed as the following.

[Vertical installation]

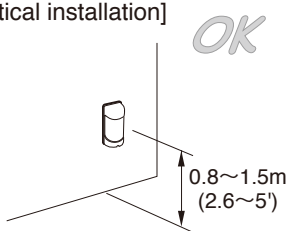

[Horizontal installation]

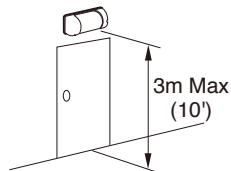

- Remove obstructions, including glasses, from the detection zones.

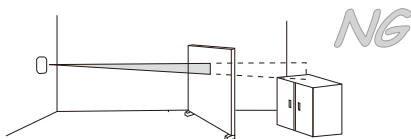

- In case of outdoor installation, adjust the lens holder to 2°, 4°, 6° downward from horizontal.

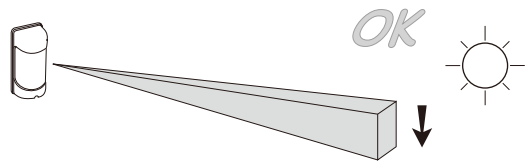

- Install in a site which avoid direct sunlight. If not, use the filter. (See below)

- Do not install the unit by an air conditioning exhaust vent. Remove all obstructions (trees, clotheslines, etc.)

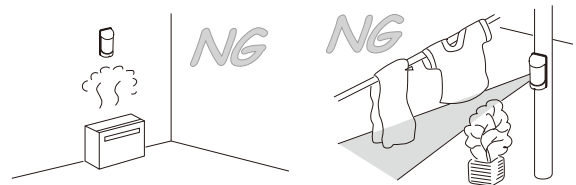

- Do not install in a site which is subject to electrical noise or vibration.

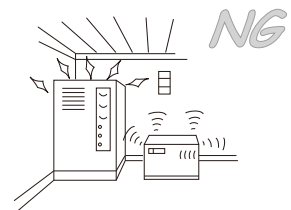

- Check the detection zones before operation. (Unexpected objects may be detected.)

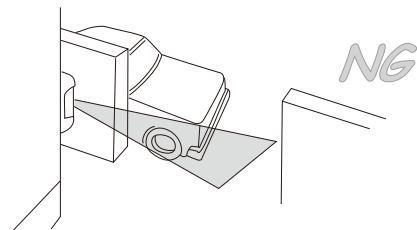

2. Other Precautions

- Avoid using the unit for primary security purpose. (The unit is designed to detect infrared energy variation caused by a human body. Therefore, similar variations in conditions due to other reasons, may cause the sensor to output a signal as it is unable to distinguish between the sources.)

- Insert the filter between the lens and the lens holder when using the unit in a site which is subject to direct sunlight.

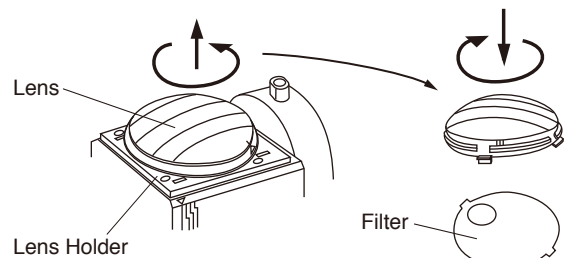

- The filter reduces influence of sunlight. (This also lowers the sensitivity.) Check the sensitivity by a walk test.

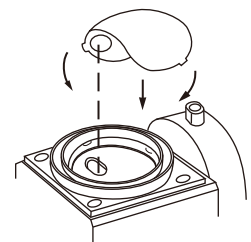

4 DETECTION AREA

MS-100E can set up 4 different patterns of coverage with 2 types of lens.

1. Detection chart

Installation	Vertical Installation			Horizontal Installation
Mounting Position	Indoor / Outdoor Mounting Height 0.8~1.5m (2.6~5')			Indoor Height 3m (10')
Detection Area (Wide Angle : Set at factory)	Wide Angle [Max. 10m (33')]	Curtain [Max. 10m (33')]	Long Range [Max. 20m (66')]	Curtain [Max. 3m (10')]
Coverage				
Lens	Lens (Attached at Factory)		Lens for Long Range	Lens (Attached at Factory)
Lens setting				
Cautions on Outdoor Mounting	<ul style="list-style-type: none"> ● Install properly. ● Do not fail to set coverage to a lower angle than horizontal. (2°, 4°, 6°) 			<ul style="list-style-type: none"> ● Do not install in a site which is subject to direct rainfall.

2. Lens Setting

- ① Adjust lens holder to set holder level to 0°.
- ② Remove lens from lens holder.
- ③ Refer to lens setting in chart (4. 1). Attach appropriate lens on lens holder and, adjust lens to fit Setting Mark to mark (W) or (C).

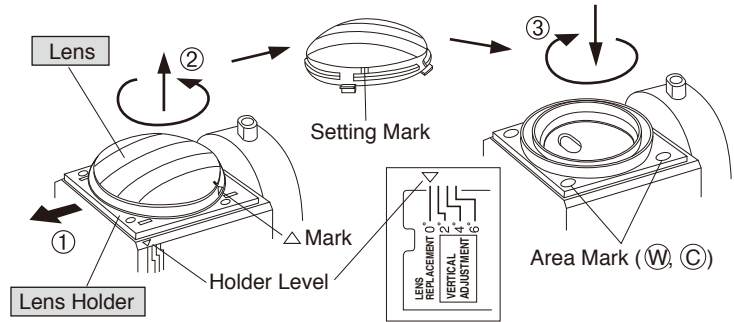

3. Angle Adjustment

(1) Angle Adjustment

① Sensor Case

[Vertical installation]

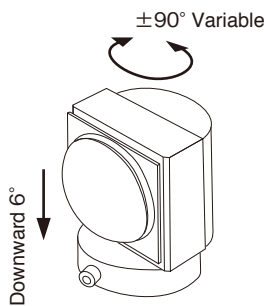

[Horizontal installation]

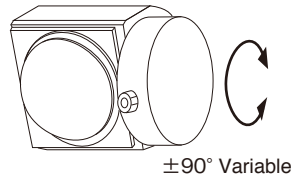

② Angle Adjustment Level

- (a) Turn sensor case to adjust the required angle. Refer to the seal on the unit.



- (b) In case of vertical installation in outdoor, adjust lens holder to set holder level to 2°, 4°, or 6°.

(2) Zone Masking

① Coverage

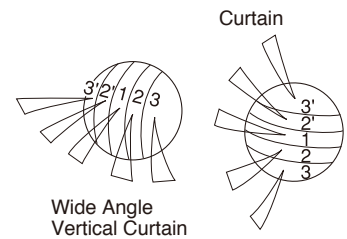
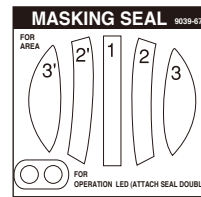

- Use zone masking seal to cut unnecessary zones.

* In case of curtain coverage, mask two upper zones with seals.

Cut off locking edges of lens and adjust lens holder to set holder level to 2°, 4°, or 6°.

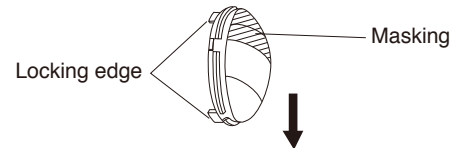

② Operation LED

Use masking seals to mask the hole of Operation LED.

5 ADJUSTMENT

● Sensitivity Adjustment

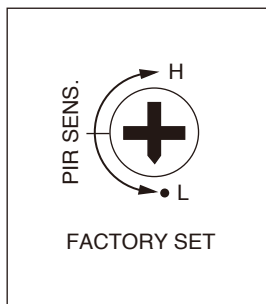

- This volume is for adjusting the sensitivity of passive infrared sensor.
- Adjust sensitivity when necessary according to environment. Usually there is no need to change the sensitivity set at the factory.

● Contact Selection

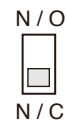

(1) OUTPUT CONTACT

- Output contact can be selectable. (N/O or N/C)

6 WIRING

1. Terminal Configuration

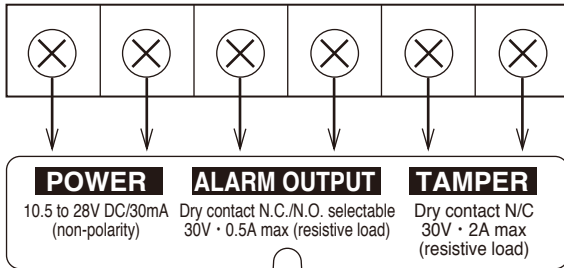

POWER

- DC10.5~28V (Non Polarity)
- Current Consumption 30mA MAX.

ALARM OUTPUT

- Dry contact relay output form N.O / N.C selectable.
- CONTACT CAPACITY :
30V (AC · DC), 0.5A MAX. (resistive load)

TAMPER

- Dry contact relay output N / C
- CONTACT CAPACITY :
30V (AC · DC), 2A MAX. (resistive load)

2. Wiring distance

Input Voltage	DC 12V	DC 24V
Size of Wire		
AWG 22 (Dia. 0.65mm)	Up to 350m (1150ft)	Up to 3400m (11000ft)
AWG 20 (Dia. 0.8mm)	Up to 550m (1800ft)	Up to 5200m (17000ft)
AWG 18 (Dia. 1mm)	Up to 900m (2950ft)	Up to 8100m (26500ft)

NOTE : Maximum wiring distance when two or more sets are connected is the value above divided by number of sets.

3. Wire insertion

- Break either the top or bottom knock-outs, if necessary. Pull wire through the insertion holes.

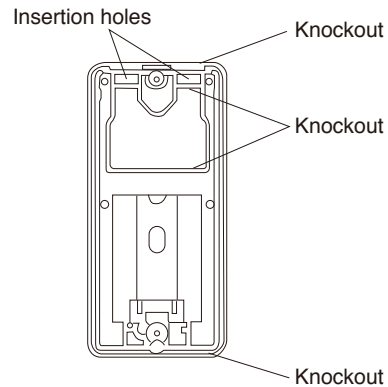

7 INSTALLATION

- ① Read (3) PRECAUTIONS before installation.
- ② Loosen the cover screw and remove cover from unit.

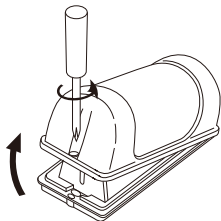

- ③ Refer to (4) DETECTION AREA and adjust to the required angle.
- ④ Refer to (6) WIRING and connect wires to the terminal.
- ⑤ Secure the body of unit to wall with screws provided.

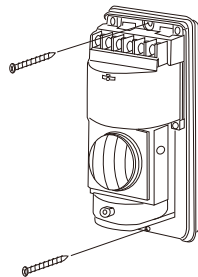

- ⑥ Refer to (8) OPERATION CHECK and check the operation.
- ⑦ Refer to (5) ADJUSTMENT set up for desired operation.
- ⑧ Replace the cover.

8 OPERATION CHECK

1. Setting for operation check

Contact ····· Form N.O. / N.C.

Adjust to the required angle.

2. Operation check

- (1) Supply power with cover detached and wait approx. 1 min for warm-up period.
- (2) After warm-up period, operate a walk test in the detection area to check, if the required area is covered. (Operation LED is activated at the time of detection.)
- (3) Readjust the sensor case or mask zones, if necessary.
- (4) Check if whole system functions well.

9 TROUBLESHOOTING

Analyze possible problems according to the following table.

Symptom	Possible Cause	Remedy
Inactive	<ol style="list-style-type: none"> 1. No power supply. Inadequate voltage. 2. Warm-up period. 3. Obstructions in the coverage. 4. Mis-alignment of coverage. 5. Stained cover. 	<ol style="list-style-type: none"> 1. Ensure correct and adequate supply voltage. 2. Wait 1 min. after power is supplied. 3. Remove obstructions. 4. Readjust. 5. Clean with soft cloth.
Malfunction False signal	<ol style="list-style-type: none"> 1. Unstable voltage. 2. Something moving or rapid temperature variation in detection area. 3. A large electric noise source is located nearby. 4. Direct sunlight shining on the unit. 5. Detecting untargetted objects. 6. Small animals. 	<ol style="list-style-type: none"> 1. Stabilize supply voltage. 2. Remove cause or change coverage. Turn the sensitivity adjustment down. 3. Remove the problem or replace the unit. 4. Remove the problem or replace the unit. Readjust the coverage. Insert the attached filter. 5. Readjust the coverage. 6. Prevent small animals from coming in or readjust unit.
Installed unit does not operate, while LED is on.	<ol style="list-style-type: none"> 1. Bad wiring connection or broken wire or short. 2. Improper terminal connection. 3. Improper unit is connected. 	<ol style="list-style-type: none"> 1. Check wiring again. 2. Check terminal connection with a tester. 3. Check connected unit.

If normal operation can not be restored by these means, contact either the dealer from whom you bought the unit or TAKEX directly.

10 SPECIFICATIONS

Sensor Switch	
Model	MS-100E
Detection system	Passive infrared
Coverage	Vertical Installation <ul style="list-style-type: none"> • Wide Angle [Max. 10m (33')] • Curtain [Max. 10m (33')] • Long Range [Max. 20m (66')] Horizontal Installation <ul style="list-style-type: none"> • Vertical Curtain [Max. 3m (10')]
Supply voltage	10.5VDC to 28VDC (Non polarity)
Current consumption	30mA or less
Alarm output	Dry contact relay output Form N.C. / N.O. selectable <ul style="list-style-type: none"> • Contact capacity : 30V (AC·DC), 0.5A MAX. (Resistive load) • Contact operation : Detection time + delay time (Approx. 2 sec.)
Tamper output	Dry contact relay output N / C <ul style="list-style-type: none"> • Contact capacity : 30V (AC·DC), 2A MAX. (Resistive load)
Sensitivity adjustment	<ul style="list-style-type: none"> • Approx. 30% (L) – Approx. 170% (H) (100% set at factory)
Ambient temperature	-4° F to +122° F (-20° C to +50° C)
Mounting position	Vertical Installation <ul style="list-style-type: none"> • Indoor / outdoor (Height 0.8 - 1.5m) Horizontal Installation <ul style="list-style-type: none"> • Indoor (Height 3m MAX.)
Operation LED	Lighting at alarm
Connection	Terminals
Weight	7.7 oz (220g)
Appearance	Cover : PE resin (white) Body : AES resin (White)
Optional	Pole cover (BP-11), Wall mount attachment (BW-14), Magnetic sheet (BR-M5), Pole attachment (BP-12)

※Specifications and design are subject to change without prior notice.

11 EXTERNAL DIMENSIONS

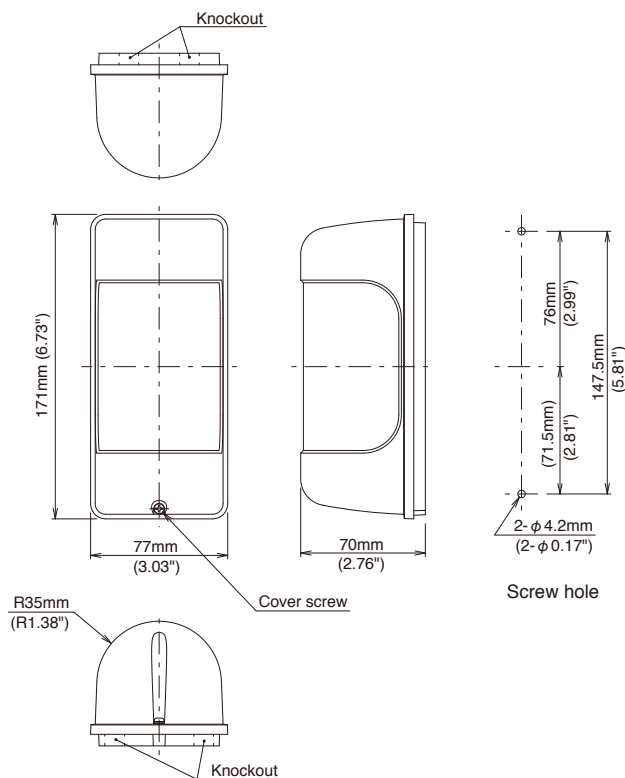

Limited Warranty :

TAKEX products are warranted to be free from defects in material and workmanship for 12 months from original date of shipment. Our warranty does not cover damage or failure caused by natural disasters, abuse, misuse, abnormal usage, faulty installation, improper maintenance or any repairs other than those provided by TAKEX. All implied warranties with respect to TAKEX, including implied warranties for merchantability and implied warranties for fitness, are limited in duration to 12 months from original date of shipment. During the Warranty Period, TAKEX will repair or replace, at its sole option, free of charge, any defective parts returned prepaid. Please provide the model number of the products, original date of shipment and nature of difficulty being experienced. There will be charges rendered for product repairs made after our Warranty Period has expired.



In Japan
Takenaka Engineering Co., Ltd.
 83-1, Gojo-sotokan, Higashino,
 Yamashina-ku, Kyoto 607-8156, Japan
 Tel : 81-75-501-6651
 Fax : 81-75-593-3816
 http : // www. takex-eng. co. jp /

In the U.S.
Takex America Inc.
 3350, Montgomery Drive
 Sant Clara, CA 95054, U.S.A.
 Tel : 408-747-0100
 Fax : 408-734-1100
 http : // www. takex. com

In Australia
Takex America Inc.
 4/15 Howleys Road, Notting Hill,
 VIC, 3168
 Tel : +61 (03) 9544-2477
 Fax : +61 (03) 9543-2342

In the U.K.
Takex Europe Ltd.
 Takex House, Aviary Court, Wade Road,
 Basingstoke, Hampshire. RG24 8PE, U.K.
 Tel : (+44) 01256-475555
 Fax : (+44) 01256-466268
 http : // www. takexeurope. com